

Ficha técnica

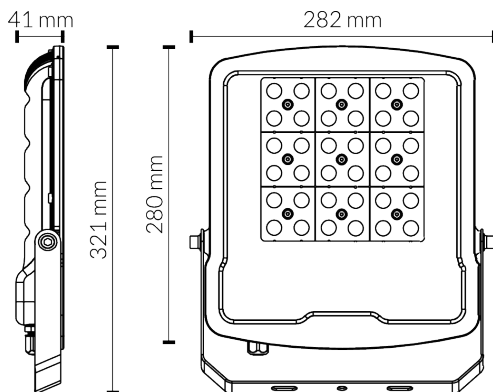

CÓDIGO	POTENCIA	LUMENS	VARIEDADE
561000380CW	100W	14500lm	175-265V

AS ESPECIFICAÇÕES TÉCNICAS

Tipo de óptica	Óptica assimétrica 80°x145°
Temperatura de cor	5700K
IRC	>80
Chip de led	Lumileds SMD 2835
Temperatura de trabalho	-20°/50°
Material	Aluminio
Acabado	Preto
Dimensões	282x321x41 mm
Certificados	CE&Rohs
Horas de vida	55.000 h
Peso	1,72 kg

